

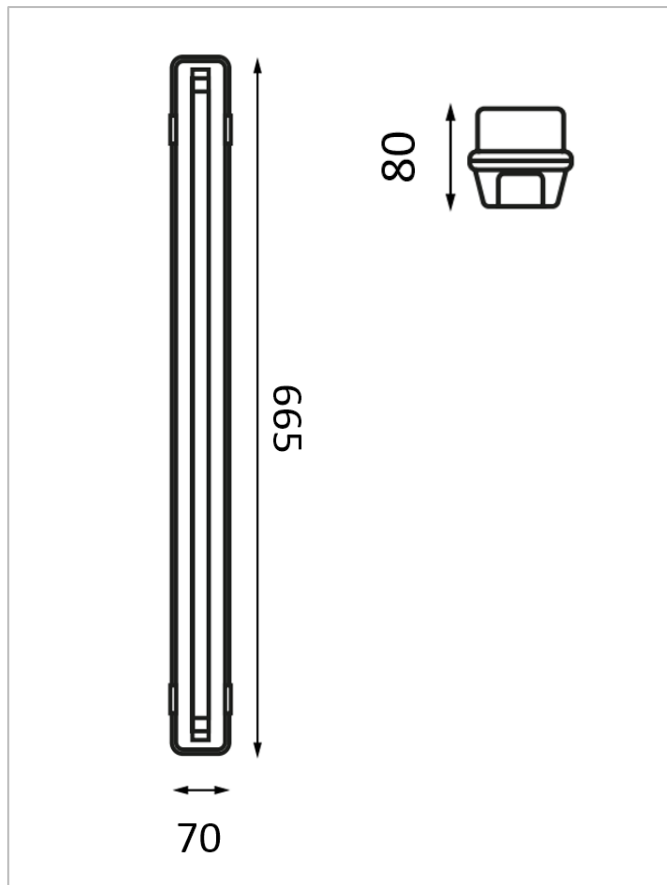

INFORMACIÓN LUMÍNICA	
REFERENCIA	POL-40361-FN
TEM. COLOR	-
COLOR DE LA LUZ	-
LÚMENES	-
EFICIENCIA	-
CRI	-
TIPO DE CHIP	-
ÁNGULO DE APERTURA	-



INFORMACIÓN TÉCNICA	
REFERENCIA	POL-40361-FN
MATERIALES	POLICARBONATO ABS
ACABADO	TRANSPARENTE
CONEXIÓN LAMPARA	G13
LAMP./P	T8 1x10 W
CONEXIÓN	1 EXTREMO
FRECUENCIA	-
IP	IP65
FACTOR DE POTENCIA	-
MEDIDAS(mm)	665x70x80
VIDA ÚTIL (h)	-
ENCENDIDOS	-
RANGO DE TEMPERATURA	-15°C 55°C
CLASIFICACIÓN	A
CERTIFICADOS	CE, ROHS
GARANTÍA	2 años

CERTIFICADOS		
CERTIFICADO	SÍMBOLO	NORMAS
CE		EN60598-1:2008+A11:2009 EN60598-2-2:2012 EN62493:2010 EN55015:2013 EN61547:2009 EN61000-3-2:2006+A1:2009+A2:2009 EN61000-3-3:2013 EN 62031:2009
ROHS		IEC 62321:2008 IEC 62321:2013



15/11/2019